

Sensors for FRC

(and Best Practices)

Scott McMahon
Mentor

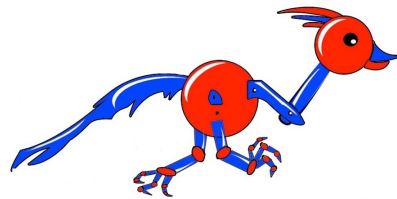

Introduction

- Created for the Alamo-FIRST Conference and Workshops, Nov 12, 2016
Thanks to Patrick Felty and the crew of Alamo-FIRST for organizing the workshops for teams in the Central Texas region
- This material was co-presented with Jeff Erickson and George Tan
Thanks to both

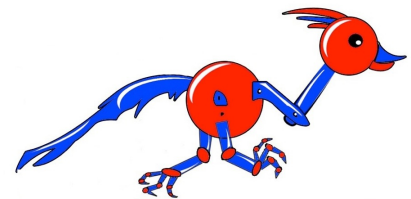

Overview

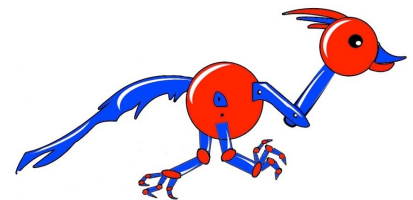

Overview

- The intent of this is to be as practical as possible and be oriented more toward rookies instead of veterans, but hopefully a veteran reading this will learn one thing
- Provide the following
 - Why use sensors
 - Application and typical sensor usage
 - Typical sensors and where/what to buy

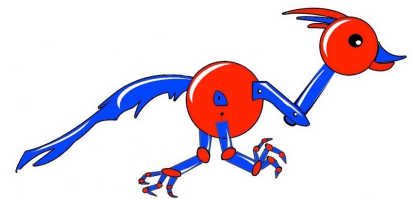

Why Sensors?

- Sensors measure things: angles, force, distance, temperature, humidity, light intensity or color, etc.
- Use sensors to measure things so software can be used to automate tasks
 - Automated movements of mechanisms
 - Automated movement of the robot
- Feedback from sensors make automation possible

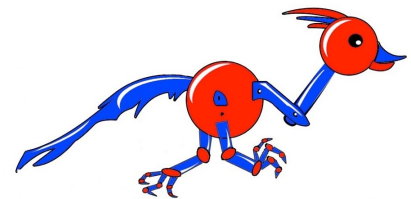

Sensor List

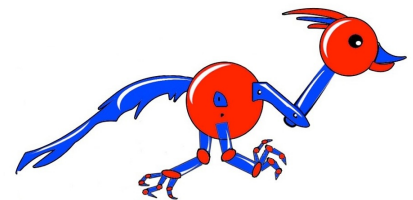

Limit Switch

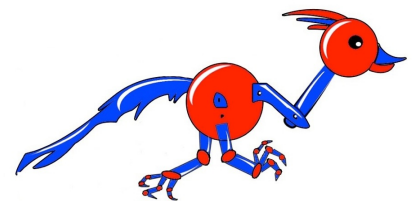
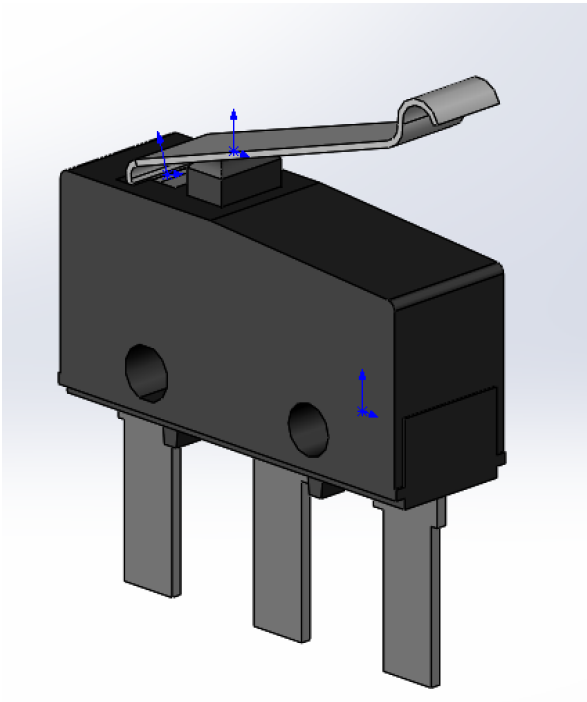

Limit Switch

- Used to indicate a mechanical mechanism has reached a specific position; often a limit of the mechanism's movement
- Mechanical mechanism's movement contacts the switch, changes the voltage to a DIO (logic level), and is sensed by software periodically reading the DIO's value
- Mechanical contact can cause damage to the switch if the mechanism's momentum applies too much force/impulse to the switch.

Tip

Having the switch mounted adjacent to the mechanism so that it contacts as it passes by can avoid mechanism overshoot damage.

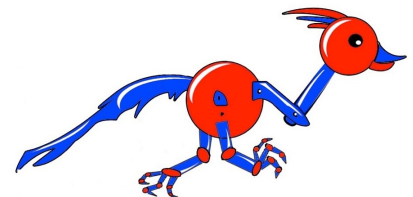

Limit Switch

- Limit switch has 3 terminals:
 - C (Common), NO (Normally Open), and NC (Normally Closed)
- Operation
 - C is connected to NC when the switch is not pressed
 - C is connected to NO when the switch is pressed
- Connection
 - C is connected to the DIO ground pin
 - NC (or NO) is connected to the DIO signal pin

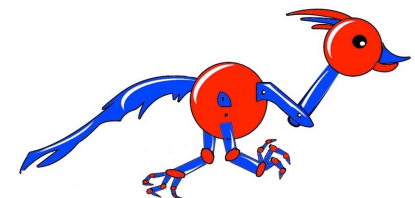

Limit Switch

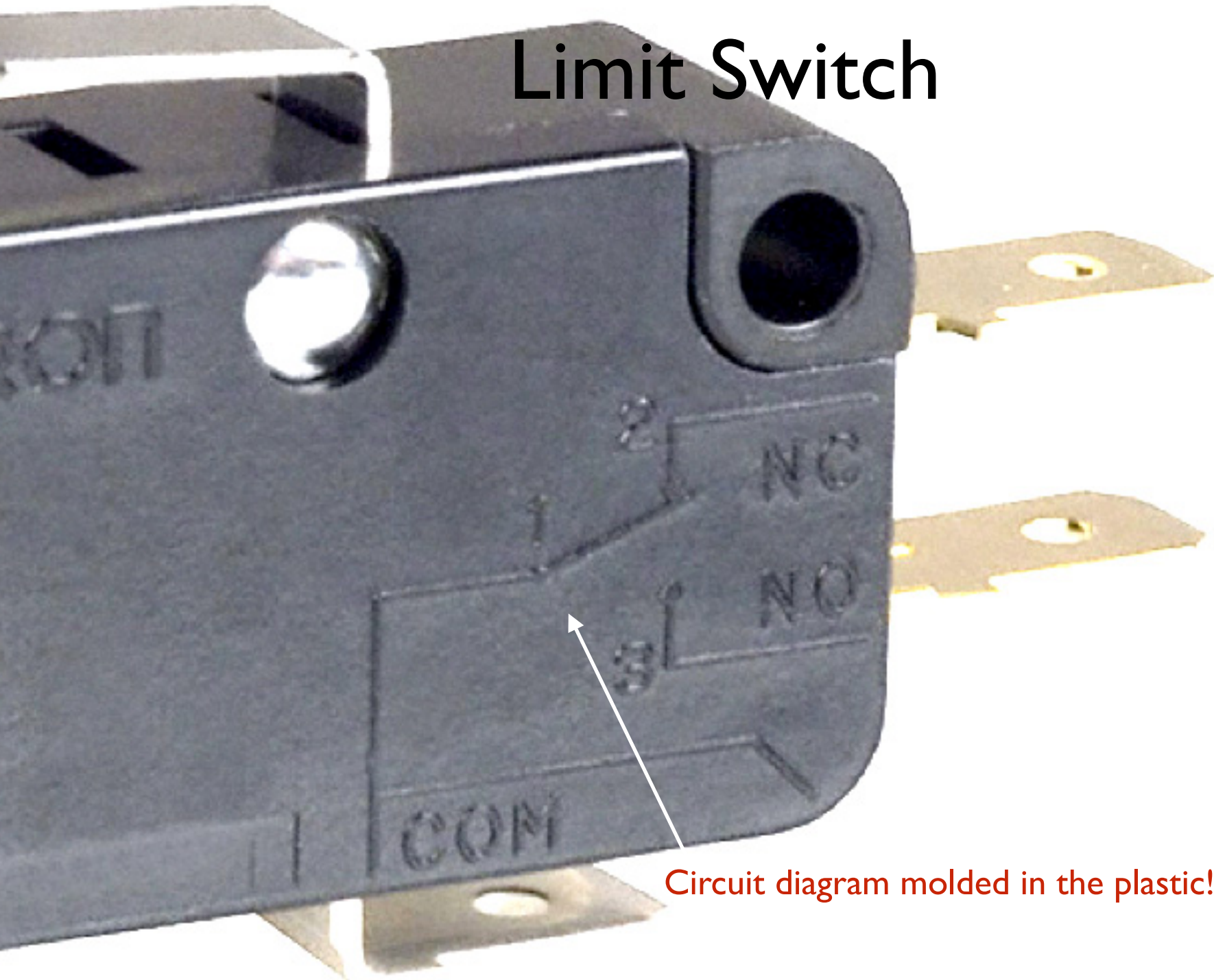

Circuit diagram molded in the plastic!

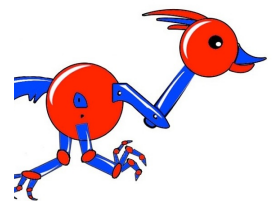

Limit Switch

- Why would you wire NC and C rather than NO and C?



Terminals	Output	Meaning
NC + C	0 V / Logic 0	Not pressed (movement ok)
NC + C	5 V / Logic 1	Pressed (movement stop)
NO + C	5 V / Logic 1	Not Pressed (movement ok)
NO + C	0 V / Logic 0	Pressed (movement stop)

Same reading for a disconnected wire
Which is safer?

Also consider wiring both NC and NO terminals DIOs if you have spare DIOs

NC	NO	State
0	1	Not pressed
1	0	Pressed
0	0	Fault
1	1	Fault

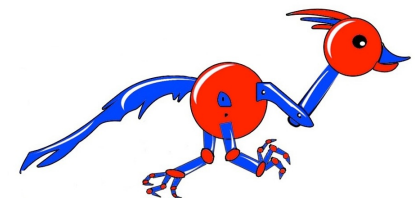

Reed Switches

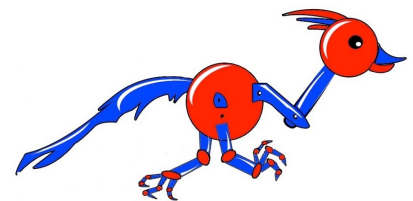

Reed Switches

- Look like resistors, but they respond to magnetic fields
- Typically switch is mounted on fixed part and magnet connected to moving mechanism that passes near to reed switch
- One side of reed switch connected to DIO ground pin and the other connected to the DIO signal pin
- Note that the orientation of the magnetic field is more effective in some orientations than others
- Sometimes it is useful to wire a couple of switches in parallel to ensure one of them will trip in the presence of the magnet

Tip

Tip

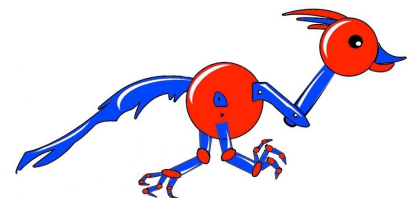

Potentiometer

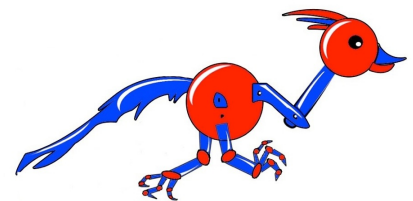
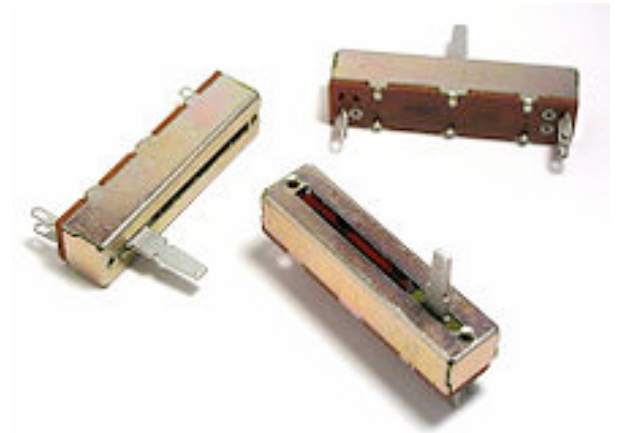

Potentiometer

- A 3 terminal variable resistor – wiper terminal and 2 end terminals
- Types: Linear (✓) and Logarithmic (✗)
- Single, 3, 5, and 10 turn varieties
- Single turn has approx 300 degrees of rotation
- Wiring
 - Pot wiper to analog signal pin
 - One end to analog ground pin and the other to analog power pin

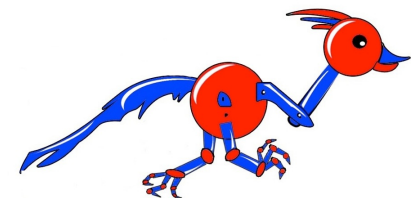
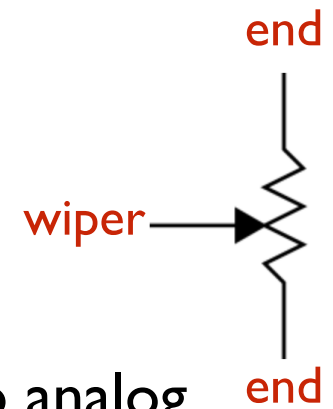

Potentiometer

- They're absolute – the resistance from wiper terminal to end terminal is proportional to the shaft angle, and this does not change with a loss in power
- Used to measure the rotation of a mechanism

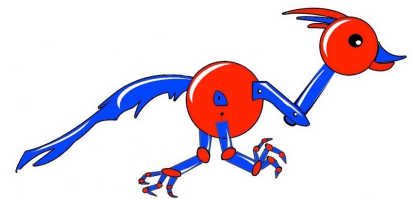

Potentiometer

- Mounting options:
 - End of shaft dowl + coupler
 - End of shaft bore + set screw
 - Gears

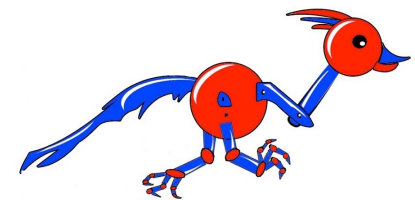
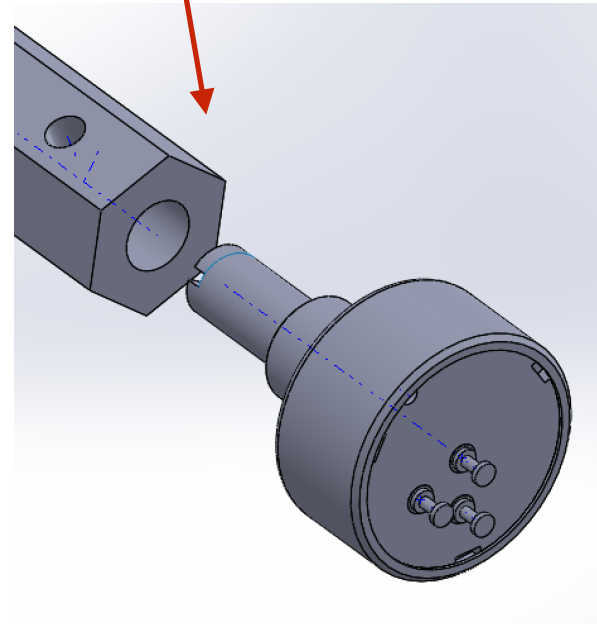
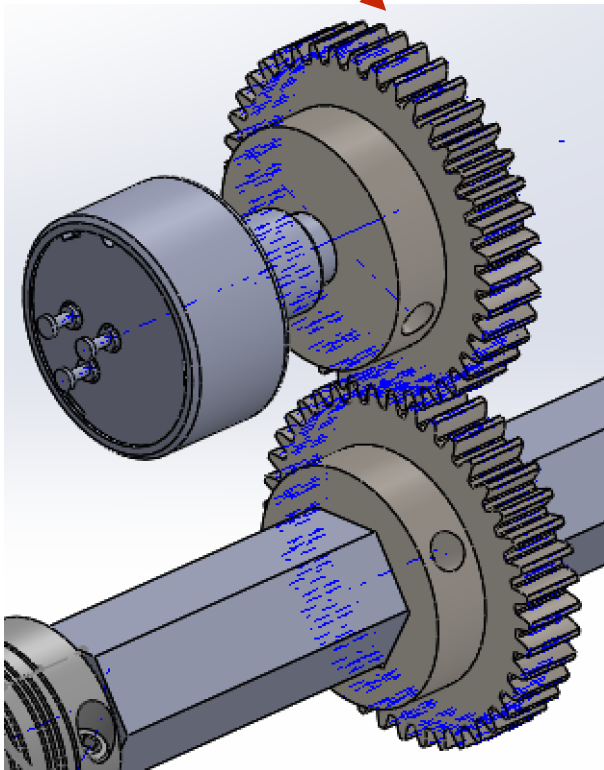
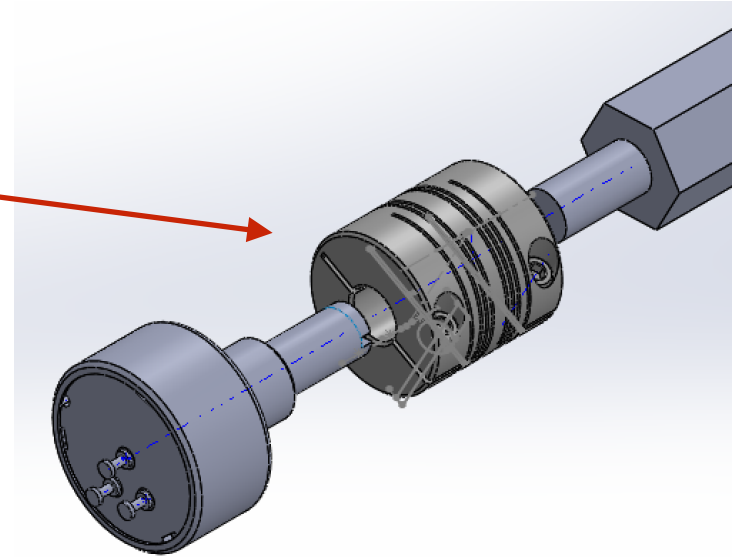

String Potentiometer

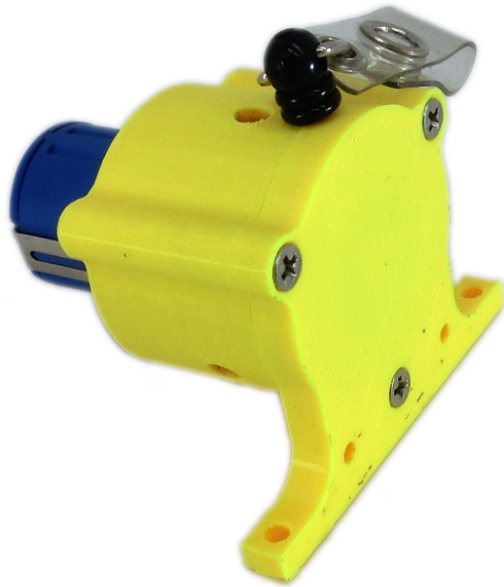

Assembled Version using modified FRC Team 2468 3D Print Files

String Potentiometer Complete Kit (am-2674)

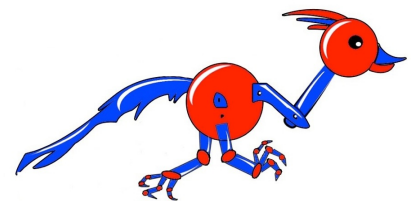

String Potentiometer

- It is a potentiometer combined with a string, spool, and spring
- As string extends/contracts potentiometer shaft turns
- Used as an electrical tape measure to determine a mechanism's linear movement
- The potentiometer is connected to the analog pins just like a potentiometer (it is a potentiometer!)

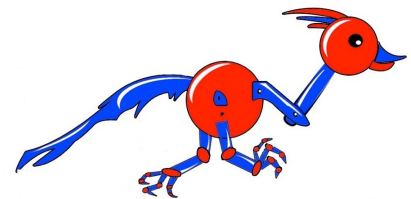

Encoders

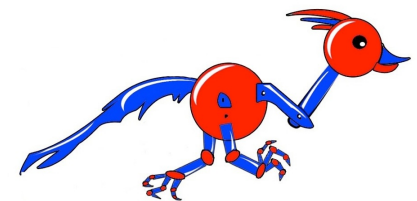

Encoder

- Typical applications
 - Measuring the speed or distance traveled by a robot
 - Measuring the angle of an arm
 - Measuring the extension of a mechanism

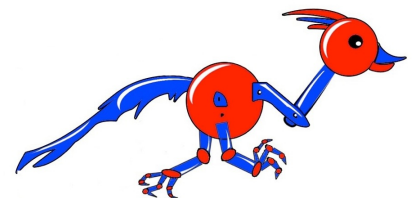

Encoder

- Two types of encoders:
 - Absolute and Incremental
- Absolute – The output indicates the absolute angle of the encoder's shaft (similar to a potentiometer) and that is read directly by software
 - Can be analog or digital output
 - Pro – immune to power glitches
 - Con – more expensive, digital take many wires (use analog!)
- Typically for measuring angles (e.g. arms, steering, ...)

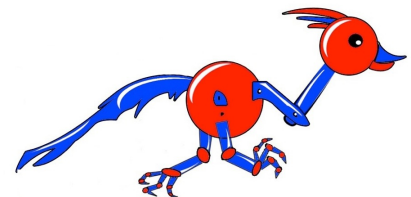

Encoder

- Incremental – The output indicates a change in angle and the software must accumulate (up and down) changes to maintain the angle
 - Pro – Cheaper than absolute
 - Con – immune to power glitches
 - Typically used on gearboxes for measuring shaft speed or position

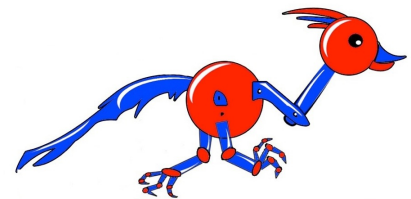

Encoder Example

- Example 1: USDigital MA3 Analog Absolute Encoder
- Very similar to a potentiometer
- 3 wire interface, 1024 voltages between ground and 5 V
- Mounts just like a potentiometer
- Pro – 360, infinite rotation, low output impedance
- Con – 3x the cost of a potentiometer, quantized output

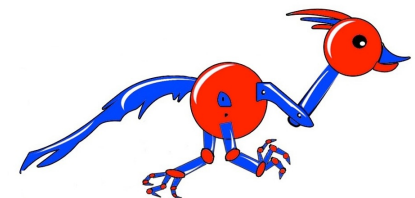

Encoder Example

- Example 1: USDigital E4T Digital Incremental Encoder
- Kit includes: base, cap, encoder ring, screws, and wires
- 4 wire interface: uses 2 DIO channels, Ground, Power, and two signals
- Use the alignment and spacer tool to center the base to dowel and space the ring from the base
- Typically attach encoder ring to dowel on shaft end

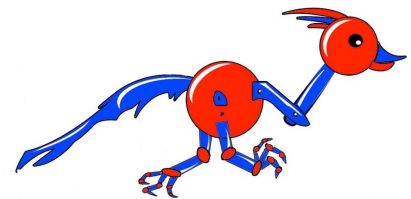
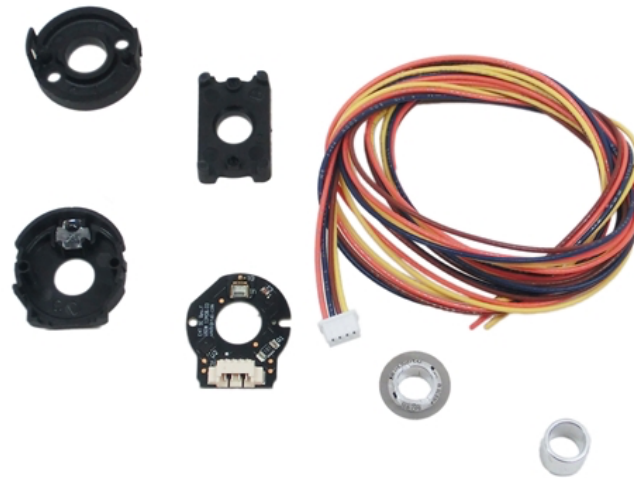

Magnetic Encoder

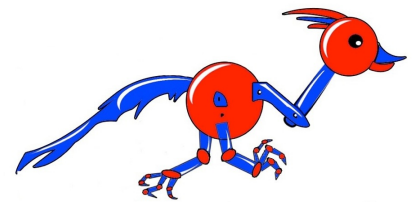
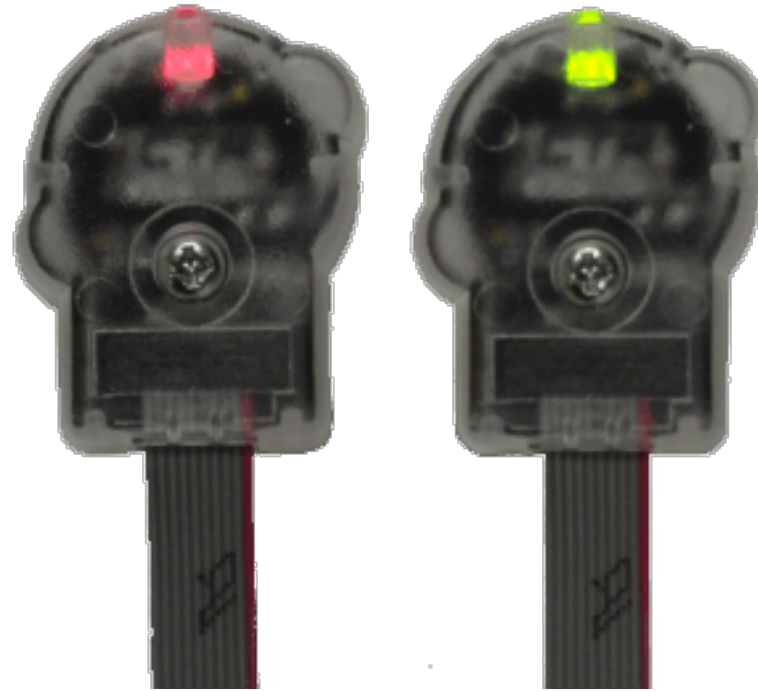

Magnetic Encoder

- Magnet embedded into shaft, encoder based put near magnet
- Encoder senses magnetic field to determine angle of shaft
- Must use consistent spacing between encoder and sensor
- Pro – Contactless!

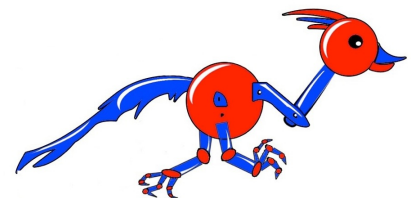

Magnetic Encoder

- CTR-electronics also makes a magnetic encoder options
- SRX Magnetic Encoder works with the Talon SRX directly
- VersaPlanetary Integrated Controller from VEXPro packages an SRX Magnetic Encoder into the gearbox

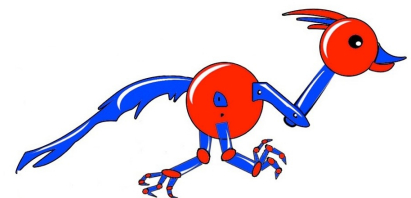

Force

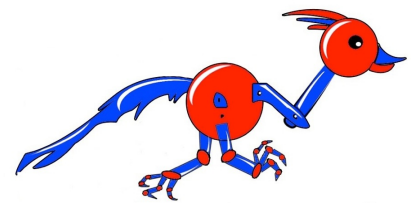
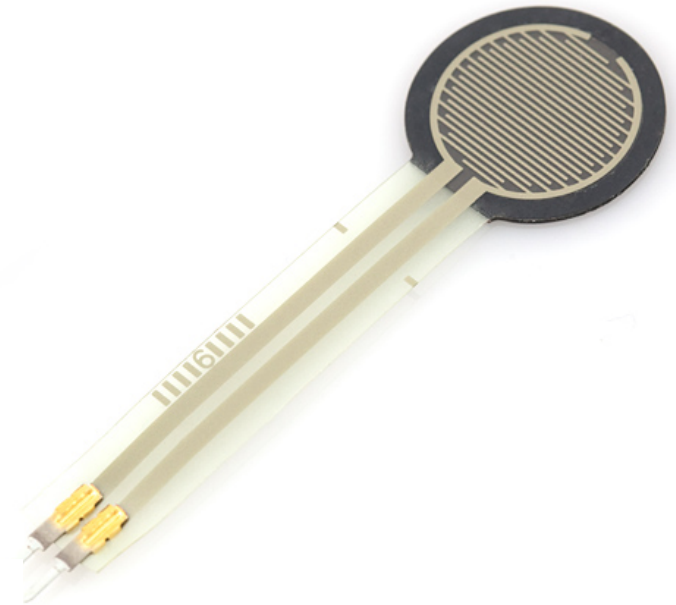
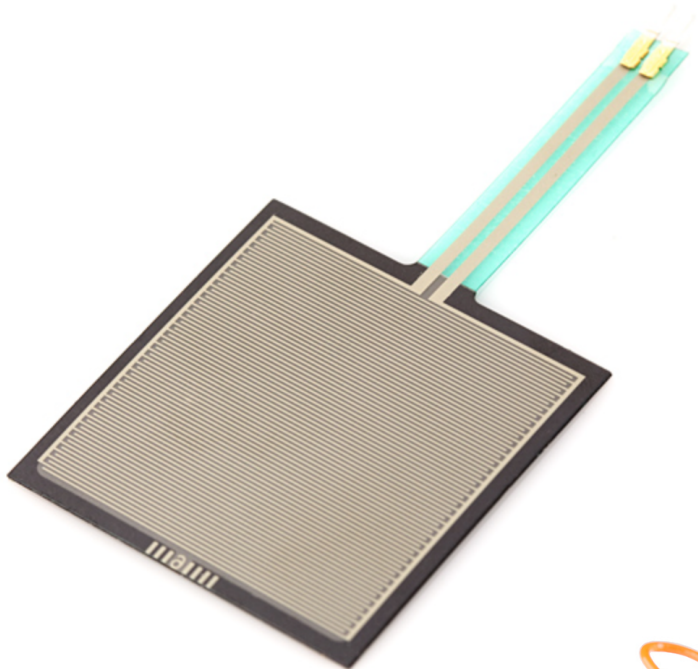

Force

- Typical applications
- Detecting capture or contact of mechanism and game object (e.g. is a gripping mechanism squeezing a ball)

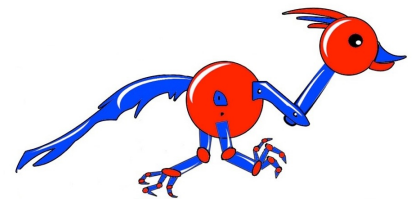

Force

- Force can be detected using a special resistor whose resistance is inversely proportional to the force applied
 - No force, resistance is approx 1 M Ω
 - Resistance drops as force applied to a rated maximum
 - Use with other resistors to create a voltage divider or bridge circuit which can be connected to the analog port
- Caution: Sensitive to shearing forces (will tear apart)
- Caution: Not particularly accurate, resistance will vary from part to part, so they will require calibration in software

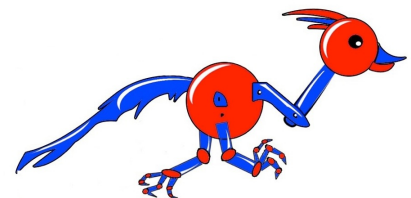
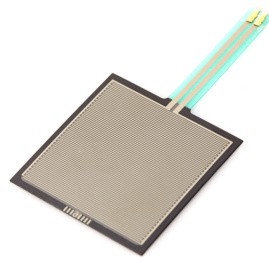

Force

- Another method to sense force is to use a load cell (strain gauge) and load cell amplifier
- Output of load cell is connected to the amplifier which is connected to the roboRIO
- Amplifier uses an I2C digital interface (this requires advanced programming)

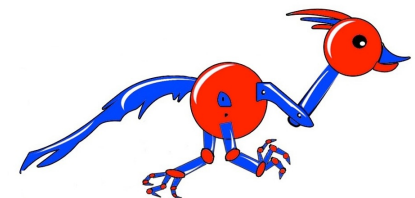
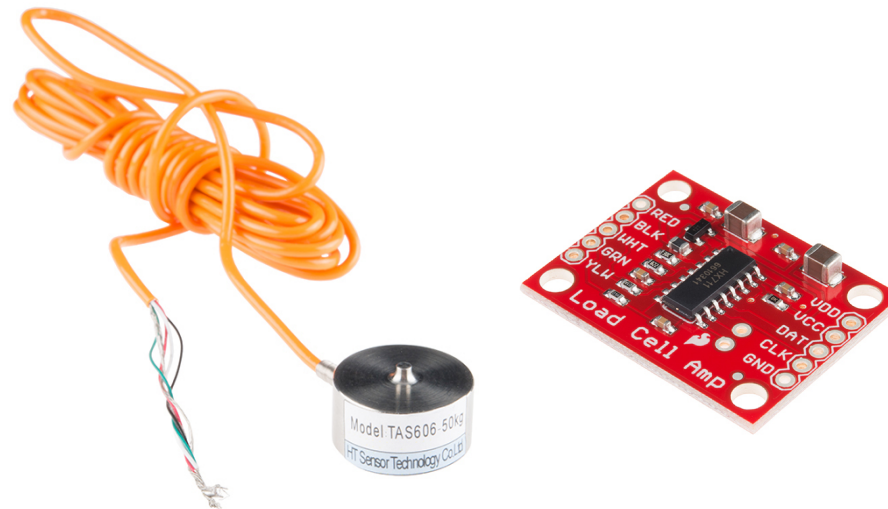

Inertial Sensors

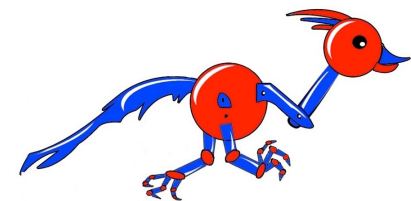
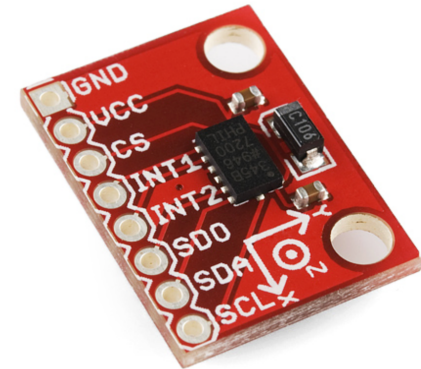
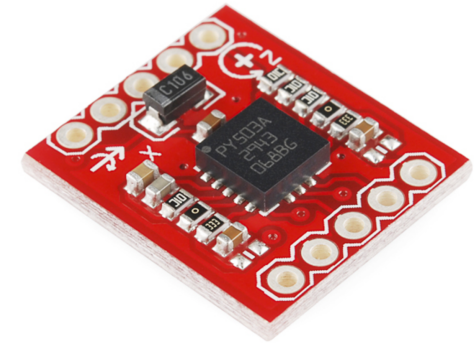
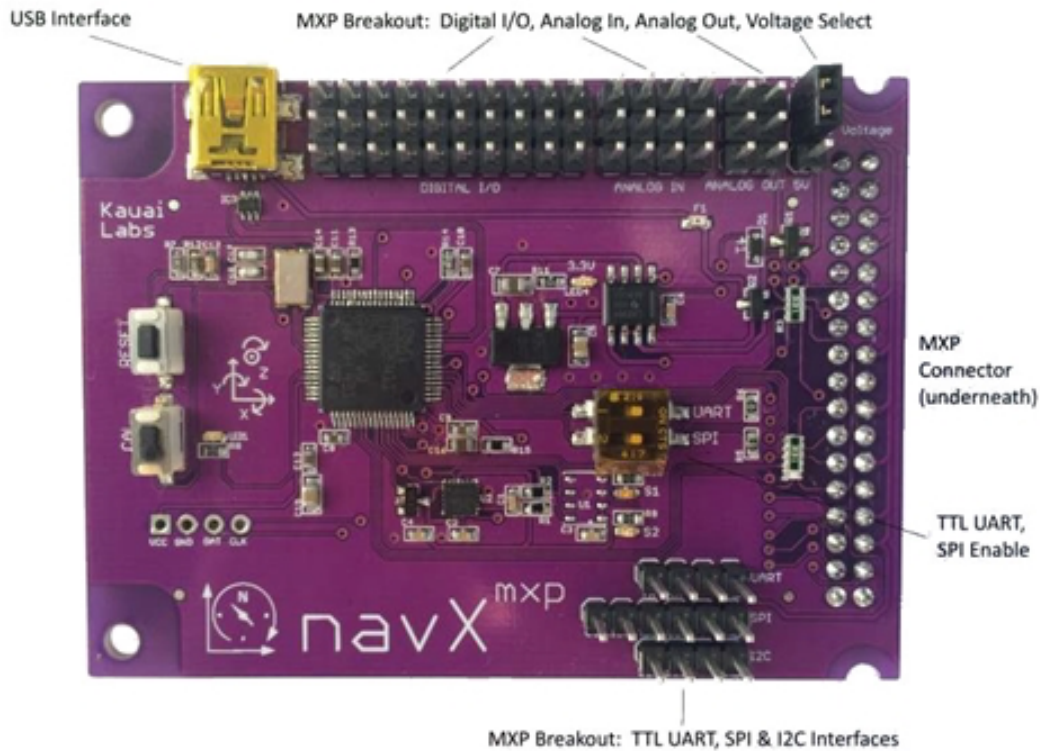

Distance Sensors

- Typical applications
 - Determining robot's position or orientation on the field for the purposes of moving the robot in autonomous or improved driver control

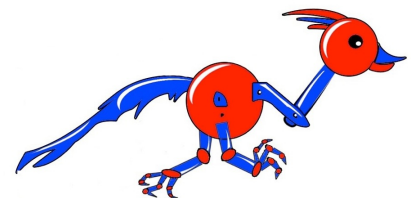

Inertial Sensors

- Two main types:
 - Gyro measures the rate of change of angle the gyro (the speed at which the robot is turning)
 - Accelerometer – measures force acting on the accelerometer, including gravity

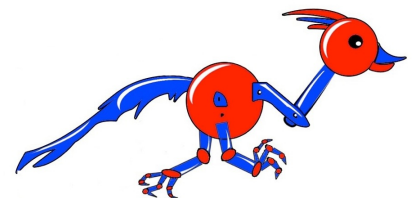

Distance Sensors

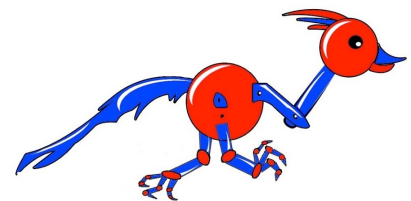
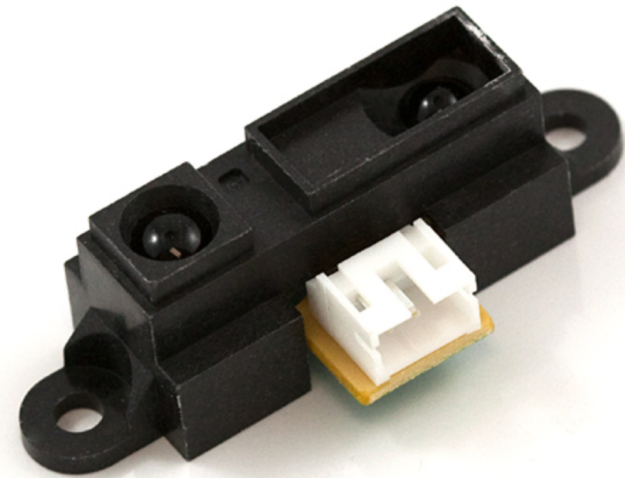

Distance Sensors

- Typical applications
 - Measuring the distance between field or field objects and the robot for navigation on the field or improved accuracy or autonomous scoring
 - Collision detection (slow down/stop)

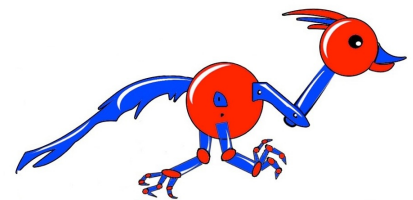

Distance Sensors

- Three main types:
 - UltraSonic
 - Infrared
 - LiDAR

Not Complete

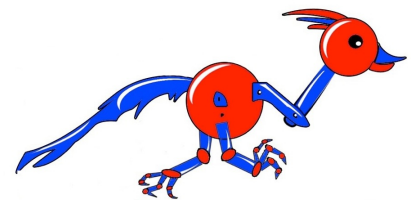

Vision

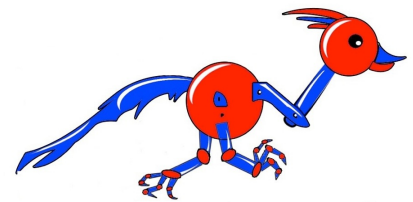

Vision

- Typical applications
 - Finding scoring goals and aligning the robot towards them for improved accuracy or autonomous scoring

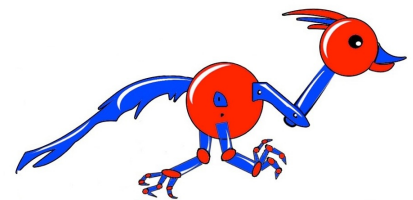

Vision

- Two main types of cameras:
 - USB connected – cable plugs into roboRIO
 - Ethernet connected – camera plugs into on-robot ethernet network
- Ethernet connected cameras make debug a little difficult if you want to connect laptop + roboRIO + radio + camera during debug without using a switch since the radio has only 2 Ethernet ports

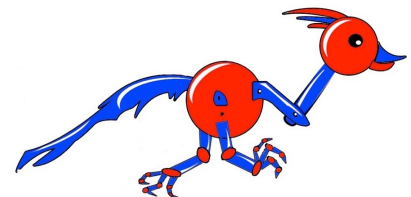

Vision

- Recommendation: If you want to use vision to calculate orientation and distance from a goal, turn towards the goal, and shoot when pointed at the goal...
- Calculate the angle from a vision picture (once)
- Use a gyro to turn the desired distance
- In other words, don't try to use vision while doing the turn – the pictures can become blurry
- Vision and cameras are a workshop presentation on their own

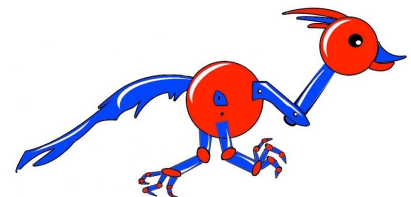

Vision

Not Complete

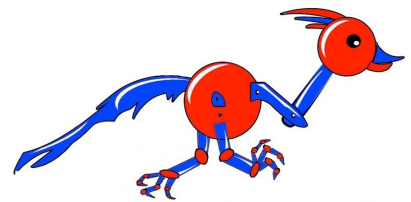

Light Reflection

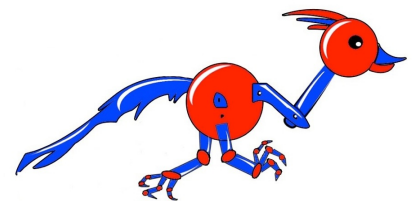

Light Reflection

- Typical applications
 - Detecting the presence of a reflective object for alignment (e.g. following a line of tape)
 - Detecting a retroreflective object (e.g. 'hot' goal detection from Aerial Assist)

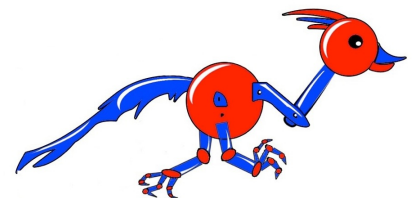

Light Reflection

- Line following

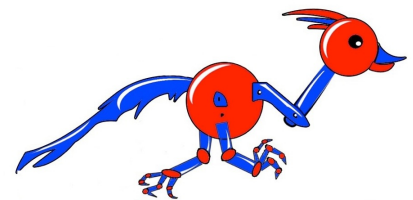

Light Reflection

- Infrared reflection sensors

Not Complete

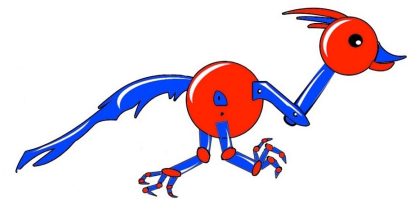

Current Sensor

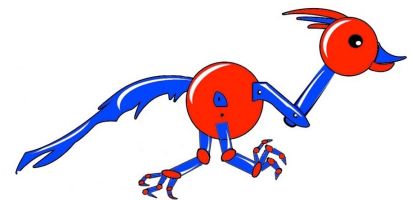

Current

- Typical applications
 - Detecting when mechanism has reached the floor or a solid object (e.g. the change in motor current from moving to stalled is detectable)
 - Preventing the current from exceeding a maximum value to avoid overheating and possibly damaging the motor (e.g. a control loop can use current as an input factor in the equation governing the output voltage)

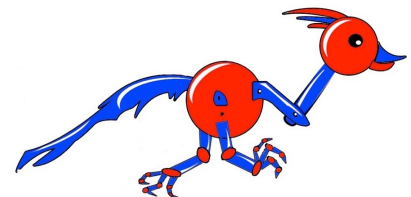

Current Sensor

- Put between PDP and a speed controller
- Measures the current going to the speed controller
 - Knowing current can avoid burning out a motor since software can reduce motor voltage when too high
 - Knowing current estimates torque provided by motor
- 3 wire interface connects to an analog port
- The PDP also provides some current sense capability

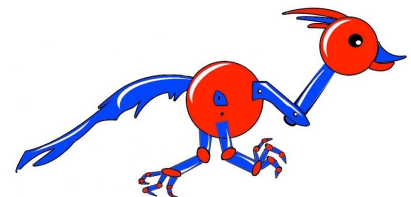

Where to buy

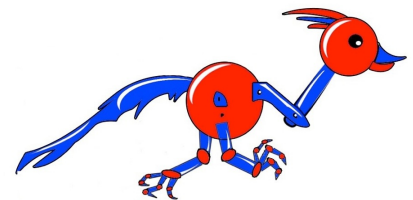

Where to Buy?

Sensor	Manufacturer	Part #	Vendor	Cost
Limit Switch	Omron	V-10G5-1C25-K	Mouser	\$4
Reed Switch	Soway	COM-10601	Sparkfun	\$2
Magnet		COM-08643	Sparkfun	\$1.50
Pot	Bourns	652-6639S-502	Mouser	\$18
String Pot	AndyMark	am-2674	AndyMark	\$40
Encoder (D)	USDigital	am-3132	AndyMark	\$42
Encoder (D)	Grayhill	63R128	Digi-Key	\$60
Encoder (A)	USDigital	am-2899	AndyMark	\$45
Encoder (D)	CUI	490-AMT103-V	Mouser	\$24
FSR	VersaPoint	sen-09376	SparkFun	\$8
Load Cell		TAS606	SparkFun	\$57
Load Cell	SparkFun	HX711	SparkFun	\$10
Ultrasonic	MaxBotix	am-2435	AndyMark	\$45
Infrared	Sharp	sen-00242	SparkFun	\$14
LiDAR	Garmin	sen-14032	SparkFun	\$150
Current		am-2709	AndyMark	\$34
Camera (U)	Logitech	C920	Amazon	\$60

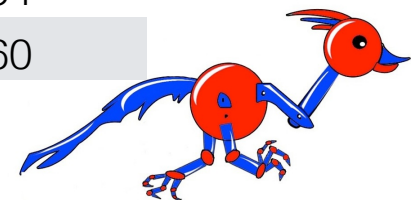

ToDo

- Get the encoder part number from Jeff
- Get new Resources tab created (Presentations) on frc2468.org and upload PDF
- Send link to Patrick for distribution
- Continue to improve (code? or software best practices)

